

Type MSV (plug-in fitting)

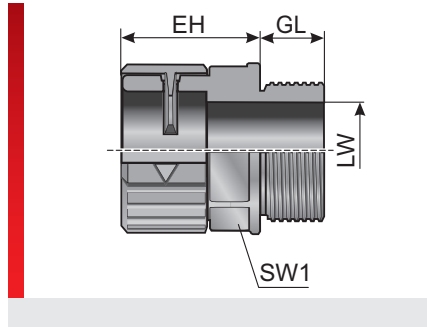

m-fix conduit fitting

PRODUCT INFORMATION

The MSV conduit fittings are made of specially modified polyamide 6. The materials are halogen, phosphor and cadmium-free. The affordable MSV conduit fittings feature the following advantages:







- No parts can get lost, delivered completely assembled
- Cost reduction through simple assembly work, insert conduit and done





- Simple opening mechanism
- Tightness of IP 54 for static and dynamic application, IP 65 with additional mounting of an O-ring

Specification:

- EN 45545-2 3x HL3
- NFPA 130: ASTM E 162, ASTM E 662
- ECE 324 R 118 Annex 6+8

SPECIFICATIONS

-  Fitting: mod. polyamide PA 6
-  -40 – 110 °C short term 140 °C
-  IP54
IP65 with sealing ring DR-NBR
-  acc. to UL94 V0 self-extinguishing
-  C.I.T. R22 / R23 HL3 : 0,58
LOI R22 / R23 HL3 : ≥ 32 %
Ds (max.) R22 / R23 HL3 : 57
ASTM E 162
-  Boeing BSS 7239
Boeing BSS 7242
Bombardier SMP 800-C
Alcohol
-  Greases
Fuels
Mineral oils

 HF
 RoHS
 EU
 UL
 Made in Germany

Article	Order No.	Color	UV	Connecting thread	Suitable for Murrflex	EH mm	GL mm	LW mm	SW 1 mm	PU pcs.
MSV-M12x1,5/7	83602450	Black	✓	M12x1,5	M10/P07	19.00	13.00	8.00	16.00	50
MSV-M12x1,5/9	83602452	Black	✓	M12x1,5	M12/P09	19.00	13.00	8.00	18.00	50
MSV-M12x1,5/11	83602456	Black	✓	M12x1,5	M16/P11	23.00	13.00	8.00	21.00	50
MSV-M16x1,5/9	83602454	Black	✓	M16x1,5	M12/P09	19.00	13.00	12.00	18.00	50
MSV-M16x1,5/11	83602458	Black	✓	M16x1,5	M16/P11	23.00	13.00	12.00	21.00	50
MSV-M20x1,5/11	83602459	Black	✓	M20x1,5	M16/P11	23.00	14.00	13.50	21.00	50
MSV-M20x1,5/16	83602460	Black	✓	M20x1,5	M20/P16(S)	27.00	14.00	15.00	27.00	50
MSV-M25x1,5/16	83602461	Black	✓	M25x1,5	M20/P16(S)	26.00	14.00	19.00	27.00	50
MSV-M25x1,5/21	83602462	Black	✓	M25x1,5	M25/P21(S)	32.00	14.00	21.00	36.00	50
MSV-M32x1,5/21	83602463	Black	✓	M32x1,5	M25/P21(S)	32.00	14.00	26.00	36.00	50
MSV-M32x1,5/29	83602464	Black	✓	M32x1,5	M32/P29(S)	34.00	14.00	27.00	40.00	25
MSV-M40x1,5/29	83602465	Black	✓	M40x1,5	M32/P29(S)	34.00	14.00	32.00	40.00	25
MSV-M40x1,5/36	83602466	Black	✓	M40x1,5	M40/P36(S)	38.00	16.00	34.00	49.00	10
MSV-M50x1,5/36	83602467	Black	✓	M50x1,5	M40/P36(S)	37.50	16.00	40.00	49.00	10
MSV-M50x1,5/48	83602468	Black	✓	M50x1,5	M50/P48(S)	39.00	16.00	44.00	60.00	10
MSV-M63x1,5/48	83602469	Black	✓	M63x1,5	M50/P48(S)	38.50	16.00	52.00	60.00	10

Type MSV (plug-in fitting)

Article	Order No.	Color	UV	Connecting thread	Suitable for Murrflex	EH mm	GL mm	LW mm	SW 1 mm	PU pcs.
MSV-M12x1,5/7	83602410	Gray		M12x1,5	M10/P07	19.00	13.00	8.00	16.00	50
MSV-M12x1,5/9	83602412	Gray		M12x1,5	M12/P09	19.00	13.00	8.00	18.00	50
MSV-M12x1,5/11	83602416	Gray		M12x1,5	M16/P11	23.00	13.00	8.00	21.00	50
MSV-M16x1,5/9	83602414	Gray		M16x1,5	M12/P09	19.00	13.00	12.00	18.00	50
MSV-M16x1,5/11	83602418	Gray		M16x1,5	M16/P11	23.00	13.00	12.00	21.00	50
MSV-M20x1,5/11	83602419	Gray		M20x1,5	M16/P11	23.00	14.00	13.50	21.00	50
MSV-M20x1,5/16	83602420	Gray		M20x1,5	M20/P16(S)	27.00	14.00	15.00	27.00	50
MSV-M25x1,5/16	83602421	Gray		M25x1,5	M20/P16(S)	26.00	14.00	19.00	27.00	50
MSV-M25x1,5/21	83602422	Gray		M25x1,5	M25/P21(S)	32.00	14.00	21.00	36.00	50
MSV-M32x1,5/21	83602423	Gray		M32x1,5	M25/P21(S)	32.00	14.00	26.00	36.00	50
MSV-M32x1,5/29	83602424	Gray		M32x1,5	M32/P29(S)	34.00	14.00	27.00	40.00	25
MSV-M40x1,5/29	83602425	Gray		M40x1,5	M32/P29(S)	34.00	14.00	32.00	40.00	25
MSV-M40x1,5/36	83602426	Gray		M40x1,5	M40/P36(S)	38.00	16.00	34.00	49.00	10
MSV-M50x1,5/36	83602427	Gray		M50x1,5	M40/P36(S)	37.50	16.00	40.00	49.00	10
MSV-M50x1,5/48	83602428	Gray		M50x1,5	M50/P48(S)	39.00	16.00	44.00	60.00	10
MSV-M63x1,5/48	83602429	Gray		M63x1,5	M50/P48(S)	38.50	16.00	52.00	60.00	10
MSV-Pg 07	83601050	Black	✓	PG 07	M10/P07	19.00	9.00	8.00	16.00	50
MSV-Pg 09	83601052	Black	✓	PG 09	M12/P09	19.00	10.00	9.60	18.00	50
MSV-Pg 11	83601054	Black	✓	PG 11	M16/P11	23.00	10.00	13.80	21.00	50
MSV-Pg 13,5/11	83601055	Black	✓	PG 13,5	M16/P11	23.00	13.00	12.00	21.00	50
MSV-Pg 13,5/16	83601056	Black	✓	PG 13,5	M20/P16(S)	27.00	13.00	15.50	27.00	50
MSV-Pg 16/09	83601057	Black	✓	PG 16	M12/P09	19.00	13.00	27.00	27.00	50
MSV-Pg 16	83601058	Black	✓	PG 16	M20/P16(S)	27.00	13.00	17.00	27.00	50
MSV-Pg 21/16	83601059	Black	✓	PG 21	M20/P16	26.00	14.00	36.00	36.00	50
MSV-Pg 21	83601060	Black	✓	PG 21	M25/P21(S)	32.00	14.00	23.00	36.00	50
MSV-Pg 29	83601062	Black	✓	PG 29	M32/P29(S)	35.00	14.00	28.00	40.00	25
MSV-Pg 36	83601064	Black	✓	PG 36	M40/P36(S)	38.00	15.00	40.00	49.00	10
MSV-Pg 48	83601066	Black	✓	PG 48	M50/P48(S)	39.00	17.00	47.00	60.00	10
MSV-Pg 07	83601010	Gray		PG 07	M10/P07	19.00	9.00	8.00	16.00	50
MSV-Pg 09	83601012	Gray		PG 09	M12/P09	19.00	10.00	9.60	18.00	50
MSV-Pg 11	83601014	Gray		PG 11	M16/P11	23.00	10.00	13.80	21.00	50
MSV-Pg 13,5/11	83601015	Gray		PG 13,5	M16/P11	23.00	13.00	12.00	21.00	50
MSV-Pg 13,5/16	83601016	Gray		PG 13,5	M20/P16(S)	27.00	13.00	15.50	27.00	50
MSV-Pg 16/09	83601017	Gray		PG 16	M12/P09	19.00	13.00	27.00	27.00	50
MSV-Pg 16	83601018	Gray		PG 16	M20/P16(S)	27.00	13.00	17.00	27.00	50
MSV-Pg 21/16	83601019	Gray		PG 21	M20/P16	26.00	14.00	36.00	36.00	50
MSV-Pg 21	83601020	Gray		PG 21	M25/P21(S)	32.00	14.00	23.00	36.00	50
MSV-Pg 29	83601022	Gray		PG 29	M32/P29(S)	35.00	14.00	28.00	40.00	25
MSV-Pg 36	83601024	Gray		PG 36	M40/P36(S)	38.00	15.00	40.00	49.00	10
MSV-Pg 48	83601026	Gray		PG 48	M50/P48(S)	39.00	17.00	47.00	60.00	10
MSV-NPT 1/2"/16 ¹⁾	83602652	Black	✓	1/2"	M20/P16(S)	27.00	14.00	15.00	27.00	50
MSV-NPT 3/4"/21 ¹⁾	83602654	Black	✓	3/4"	M25/P21(S)	32.00	14.00	20.50	36.00	50
MSV-NPT 1"/29 ¹⁾	83602656	Black	✓	1"	M32/P29(S)	35.00	16.00	26.50	40.00	25

Type MSV (plug-in fitting)

Article	Order No.	Color	UV	Connecting thread	Suitable for Murrflex	EH mm	GL mm	LW mm	SW 1 mm	PU pcs.
MSV-NPT 1/2"/16 ¹⁾	83602612	Gray		1/2"	M20/P16(S)	27.00	14.00	15.00	27.00	50
MSV-NPT 3/4"/21 ¹⁾	83602614	Gray		3/4"	M25/P21(S)	32.00	14.00	20.50	36.00	50
MSV-NPT 1"/29 ¹⁾	83602616	Gray		1"	M32/P29(S)	35.00	16.00	26.50	40.00	25
NFPA 130 applies only to the items in the product color black										
¹⁾ Discontinued product!										

MATERIAL PROPERTIES



Material

Fitting: mod. polyamide PA 6

THERMAL PROPERTIES



Temperature / temperature range

-40 – 110 °C short term 140 °C

PROTECTION CLASS



Protection class

IP54

IP65 with sealing ring DR-NBR

FIRE PROPERTIES



Fire classification

acc. to UL94 V0 self-extinguishing



Fire properties as per EN 45545-2

C.I.T. R22 / R23 HL3 : 0,58

LOI R22 / R23 HL3 : ≥ 32 %

Ds (max.) R22 / R23 HL3 : 57



Fire properties as per NFPA

ASTM E 162

Boeing BSS 7239

Boeing BSS 7242

Bombardier SMP 800-C

CHEMICAL RESISTANCE



Resistant to:

Alcohol

Greases

Fuels

Mineral oils

TECHNICAL INFORMATION



Halogen-free

CONFORMITY



RoHS (EC Directive 2011/65/EU)

Type MSV (plug-in fitting)

APPROVALS AND OPERATING PERMITS



EU railway approval
EN 45545-2 R22/R23 3x HL3



cURus approval

GENERAL INFORMATION



Made in Germany

All details given in our sales brochures and catalogues, as well as the information available online, are based on our current knowledge of the products described.

The electronic data and files made available by Murrplastik, particularly CAD files are based on our current knowledge of the product described.

A legally binding assurance of certain properties or the suitability for a certain purpose can not be determined from this information.

All information with respect to the chemical and physical properties of Murrplastik products, as well as application advice given verbally, in writing or by tests, is given to the best of our knowledge.

They do not release the buyer from the obligation to carry out his own tests and trials in order to determine the concrete suitability of the products for the intended purpose.

Murrplastik accepts no responsibility for the available information being up-to-date, correct or complete. Neither do we accept responsibility for the quality of this information.

Murrplastik accepts no liability for damage caused as a result of using our products.

Murrplastik reserves the right to make technical changes and improvements through constant further development of products and services.

Our General Terms and Conditions apply.

© Murrplastik Systemtechnik GmbH • proID_65414~20220929~890283~suv_msv